

KIRK SOFA

* NOT TO SCALE

W: 200cm - One Seat Pad,
Two Medium Back Cushions

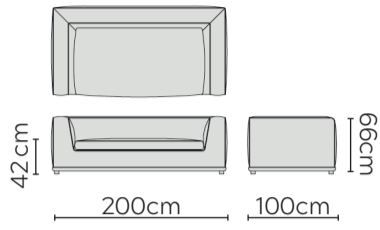

W: 245cm - Two Seat Pads,
Three Medium Back Cushions
OR Two Large Back Cushions

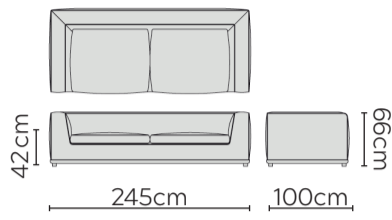

W: 280cm - Two Seat Pads,
Three Medium Back Cushions
OR Two Extra Large Back Cushions

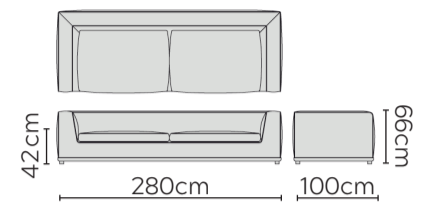

Medium Back Cushion

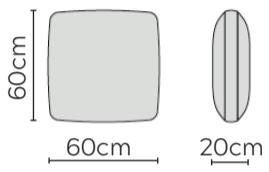

Large Back Cushion

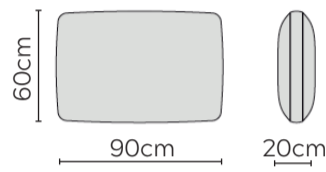

Extra Large Back Cushion

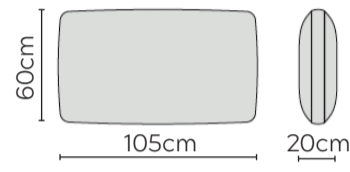

Pouf

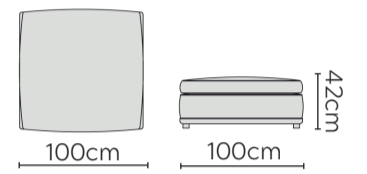

SOFA COMPOSITIONS

AS VIEWED FROM AN AERIAL POSITION

CONTACT THE SHOWROOM FOR DETAILS OF FURTHER COMPOSITIONS

COMPOSITION A

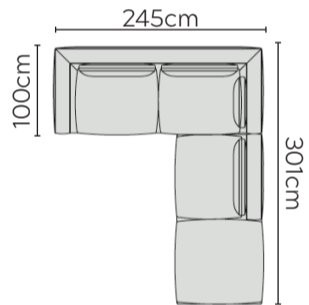

COMPOSITION B

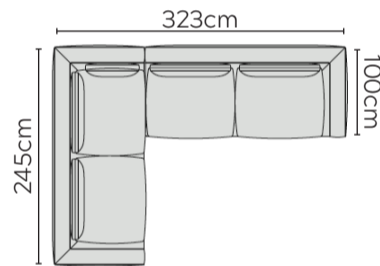

COMPOSITION C

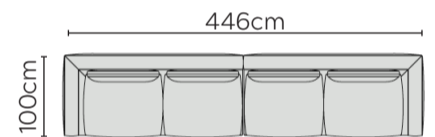

COMPOSITION D

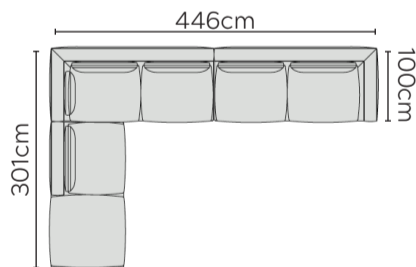

COMPOSITION F

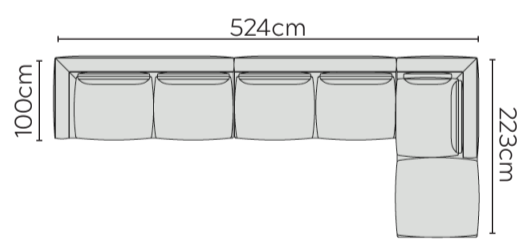

COMPOSITION G

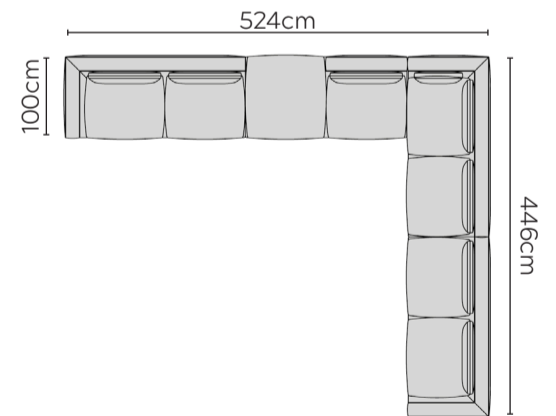

COMPOSITION I

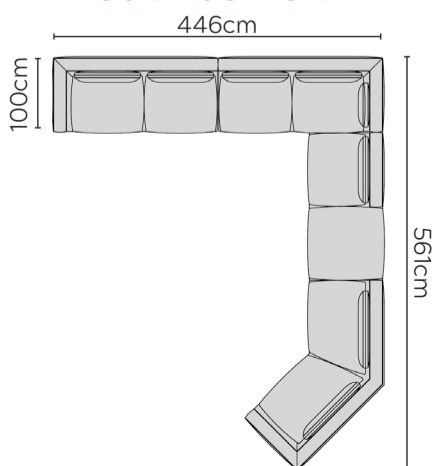

COMPOSITION L

