

CANE-LINE ARCH HIGHBACK CORNER SOFA WITH ARMS

* NOT TO SCALE

LEFT OR RIGHT COMPOSITION IS AS VIEWED FROM A SEATED POSITION



2 SEATER
MODULE



SINGLE
MODULE



3 SEATER
MODULE



BACKREST /
ARMREST



TABLE

COMPOSITION 1

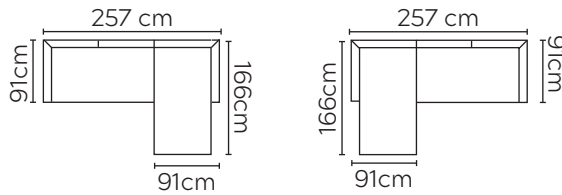

LEFT

RIGHT

COMPOSITION 2

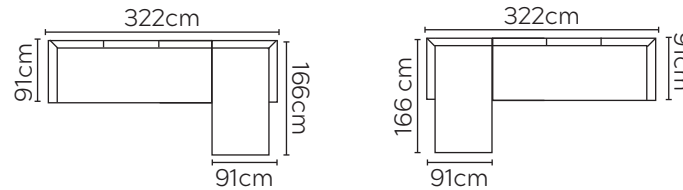

LEFT

RIGHT

COMPOSITION 3

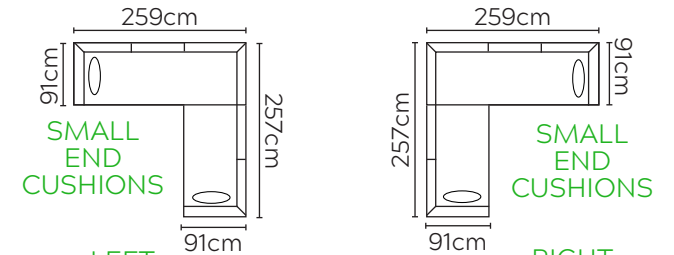

LEFT

RIGHT

COMPOSITION 4

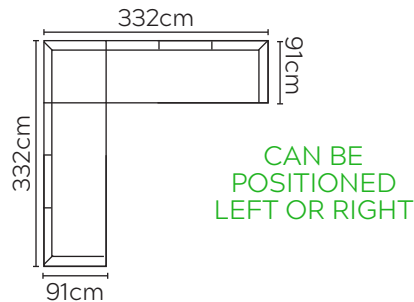

CAN BE
POSITIONED
LEFT OR RIGHT

COMPOSITION 5

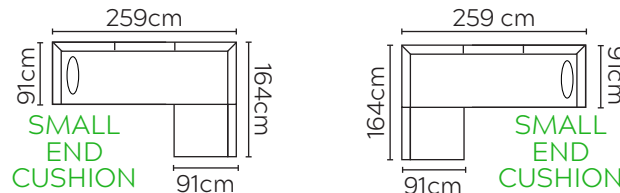

SMALL
END
CUSHION

SMALL
END
CUSHION

LEFT

RIGHT

COMPOSITION 6

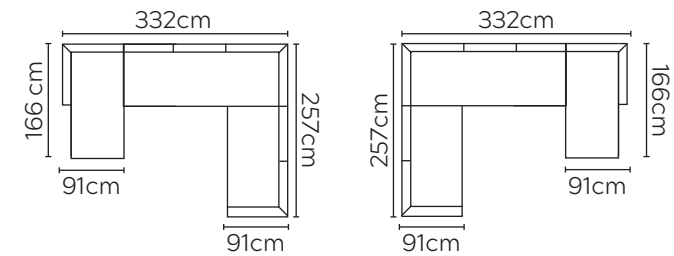

LEFT

RIGHT

COMPOSITION 7

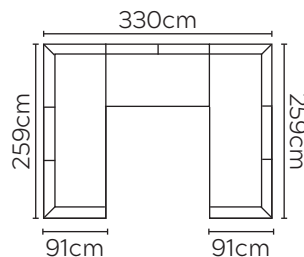

COMPOSITION 8

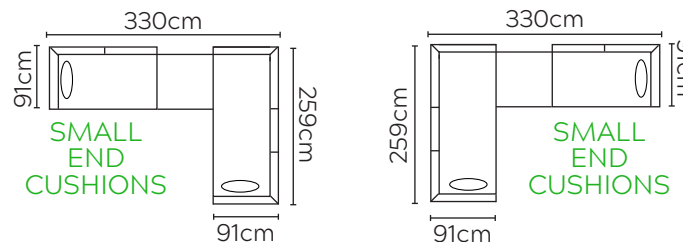

SMALL
END
CUSHIONS

SMALL
END
CUSHIONS

LEFT

RIGHT

COMPOSITION 9

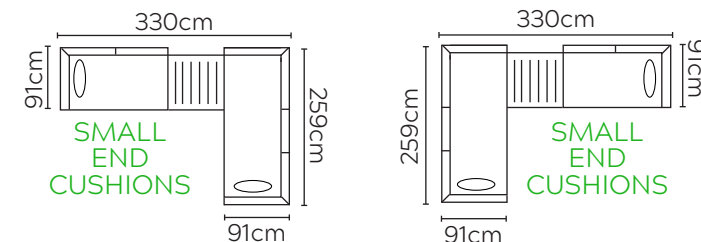

SMALL
END
CUSHIONS

SMALL
END
CUSHIONS

LEFT

RIGHT